

**FEATURES**

- Compact size and energy dense
- Higher voltage
- Quick charge and discharge
- RoHS & Reach compliant

**APPLICATIONS**

- Pulse power demand
- Ride thru power support
- Back up power
- Stand alone or augment existing energy/power source



**GENERAL SPECIFICATIONS**

Item	Performance
Operating temperature	-15°C to +70°C @ 3.8V -15°C to +85°C @ 3.5V
Storage temperature	-25°C to +70°C
Capacitance	30F
Capacitance tolerance	+/-20%
Rated voltage	3.8 VDC / 3.5 VDC
Minimum rated voltage	2.2 VDC
Surge voltage	4.2 VDC
Temperature characteristics	Capacitance change: Within ±50% of initial measured value at +25°C (-15°C to +70°C) Internal resistance: Within ±800% of initial measured value at +25°C (at -15°C)
Endurance (At rated voltage & max. operating temp)	After 1000 hours: Capacitance change: ±30% of initial rated value Internal resistance: Within 2 times of initial specified value
Projected cycle life (From rated voltage to 1/2 rated voltage at 25°C)	After 500,000 cycles: Capacitance change: Within ±30 % of initial rated value Internal resistance: Within 2 times of initial specified value
Shelf life	After 1000 hours storage, at 70°C without load, the capacitor shall meet the specified endurance limits.

**DIMENSIONS**

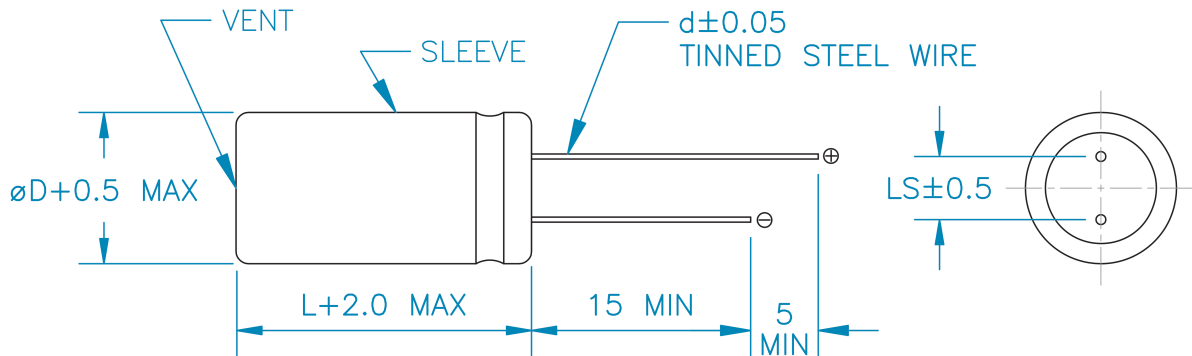

**STANDARD PRODUCTS**

Part Number	UL	Nom. Cap. (F)	ESR AC (mΩ) (1 KHz)	ESR DC Typical (mΩ)	Leakage Current (mA)	Dimensions (mm)				Rated Current (A)	Max Current (A)	Weight/Unit (grams)
						D	L	d	LS			
TPLC-3R8/30MR10X16		30	260	500	0.001	10	16	0.6	5	0.15	2.4	2.3