

FEATURES

- Small size and low resistance
- Quick charge and discharge
- RoHS compliant
- UL recognized
- Sealed for improved performance in elevated humidity environments



APPLICATIONS

- Pulse power demand
- Hybrid battery packs
- Portable electronic devices

GENERAL SPECIFICATIONS

Item	Performance
Operating temperature	-40°C to +65°C @ 2.7V -40°C to +85°C @ 2.3V
Storage temperature	-40°C to +70°C
Capacitance	1F
Rated voltage	2.7 VDC / 2.3 VDC
Surge voltage	2.85 VDC
Temperature characteristics	Capacitance change: Within $\pm 5\%$ of initial measured value at +25°C (-40°C to +65°C) Internal resistance: Within $\pm 50\%$ of initial measured value at +25°C (at -40°C)
Endurance (At rated voltage & max. operating temp)	After 1000 hours: Capacitance change: $\pm 30\%$ of initial rated value Internal resistance: Within 2 times of initial specified value
Projected Load life (At rated voltage & 25°C)	After 10 years: Capacitance change: Within $\pm 30\%$ of initial rated value Internal resistance: Within 2 times of initial specified value
Projected cycle life (From rated voltage to 1/2 rated voltage at 25°C)	After 500,000 cycles: Capacitance change: Within $\pm 30\%$ of initial rated value Internal resistance: Within 2 times of initial specified value
Shelf life	After 2 years at 25°C without load, the capacitor shall meet the specified endurance limits.
Biased humidity life	3000 hours of continuous charging at VR, 60°C and 90%RH for mechanical integrity

DIMENSIONS

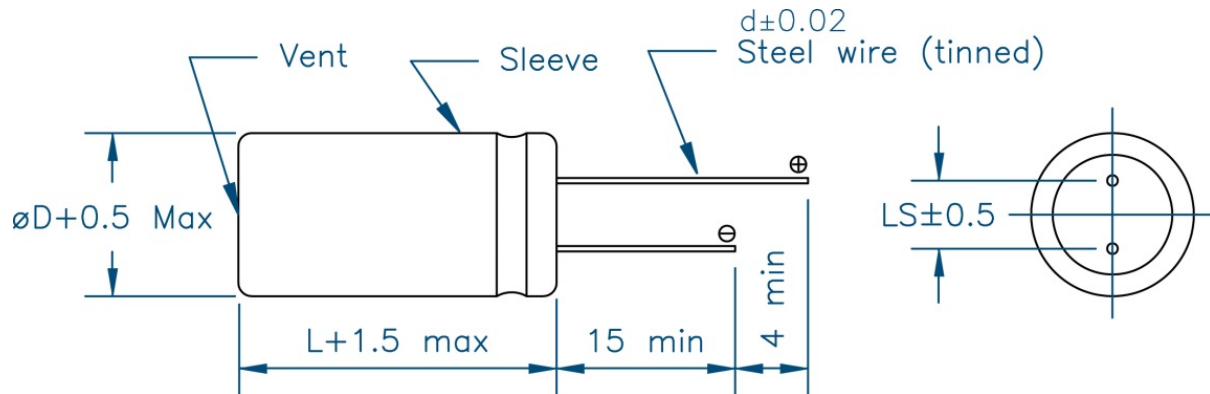

STANDARD PRODUCTS

Part Number	Nom. Cap. (F)	GMV (F)*	ESR DC (mΩ)	ESR AC (mΩ) (1 KHz)	Leakage Current (mA) (72 hrs @ 25C)	Dimensions (mm)				Rated Current (A)	Weight/Unit (grams)
						D	L	d	LS		
TPL-1.0/8X12F	1	0.9	700	315	0.006	8	12	0.6	3.5	0.79	1.1

*NOTE: GMV = Guaranteed Minimum Value.