

FEATURES

- Passive cell balancing
- Rugged, fully enclosed system
- Screw terminals
- UL-recognized cells
- Accessory pack included:
1 bus bar; 4 spring pins; 4 screws

APPLICATIONS

- Automotive subsystems
- Heavy-duty vehicle subsystems
- Windmill pitch control systems
- Wireless transmission



GENERAL SPECIFICATIONS

Item	Performance
Operating temperature	-40°C to +65°C
Storage temperature	-40°C to +70°C
Capacitance	87F
Rated voltage	12 VDC
Temperature characteristics	Capacitance change: Within $\pm 5\%$ of initial measured value at +25°C (-40°C to +65°C) Internal resistance: Within $\pm 50\%$ of initial measured value at +25°C (at -40°C)
Endurance (At rated voltage & max. operating temp)	After 1500 hours, the capacitor shall meet the following limits: Capacitance change: Within $\pm 30\%$ of initial rated value Internal resistance: Within 2 times of initial specified value
Projected Load life (At rated voltage & 25°C)	After 10 years: Capacitance change: Within $\pm 20\%$ of initial rated value Internal resistance: Within 2 times of initial specified value
Projected cycle life (From rated voltage to 1/2 rated voltage at 25°C)	After 500,000 cycles: Capacitance change: Within $\pm 20\%$ of initial rated value Internal resistance: Within 2 times of initial specified value
Shelf life	After 2 years at 25°C without load, the capacitor shall meet the specified endurance limits.

DIMENSIONS

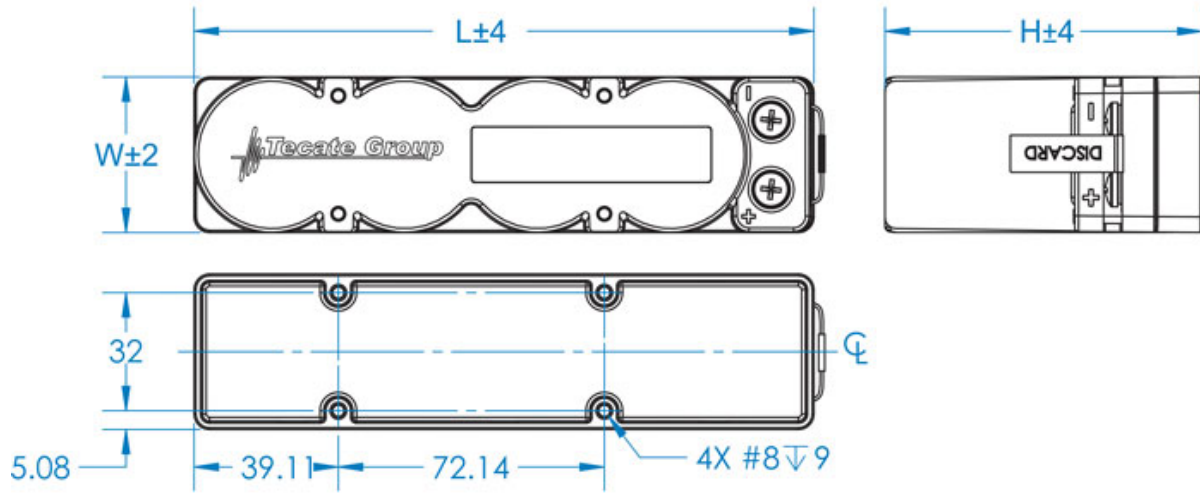

STANDARD PRODUCTS

Part Number	Nom. Cap. (F)	GMV (F)*	ESR DC (m Ω)	ESR AC (m Ω) (1 KHz)	Leakage Current (mA) (72 hrs @ 25C)	Dimensions (mm)			Rated Current (A)	Weight/Unit (grams)
						L	W	H		
PBLH-12R0/87WT	87	87	25	20	10	168	42	86	164	470

*NOTE: GMV = Guaranteed Minimum Value.