

This application note describes the use of the MEMS sensor MiCS-5521 or the MiCS-5524 in breathalyser applications. The package and the mode of operation illustrated in this document target the detection of ethanol in the human breath.

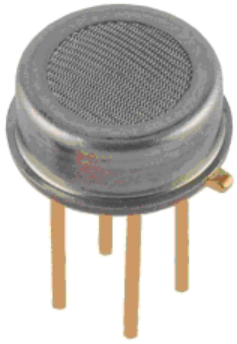

MiCS-5521 sensor
TO39 package



MiCS-5524
SMD package



Illustration of application

ALCOHOL DETECTION PRINCIPLE

The semiconducting metal oxide undergoes characteristic changes in impedance upon electronic charge transfer (e⁻) during catalytic reactions with deoxidising or reducing gases, e.g. alcohol (ethanol C₂H₅OH) or VOCs, present in the ambient atmosphere.

SENSOR PERFORMANCES

Working voltage	2.4	V
Maximum current	36	mA
Power typical/max	76/88	mW
Resistance in air (typical)	100	kΩ in air at 20°C / 50% RH
Response to Ethanol (typical)	0.35	Ratio R _{air} /R@130 ppm
Detection range	5 to 1000	ppm Ethanol
Response time / t ₉₀	< 2 s	T ₉₀ at 60 ppm Ethanol

SENSITIVITY TO ETHANOL

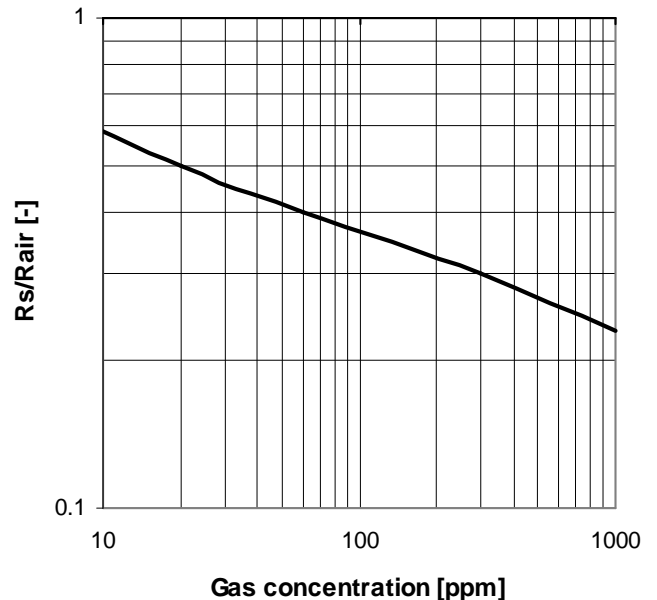

Figure 1: Sensitivity to Ethanol (C₂H₅OH) in breathalyser conditions 35 °C and 95% RH and 20 l/min airflow

APPLICATION - BREATHALYSER

Over the years, breath testing has become a widely used method for quantitative determination of the level of intoxication of individuals suspected of driving while under the influence of alcohol. After recognition of the need for quantitative assessment of intoxication, blood alcohol concentration was considered as the single most important variable. However concern about the invasiveness of drawing a blood sample led to the development of the breath test as a non-invasive means of assessing level of intoxication. The breath test is an indirect test, but has been considered to be a good estimate of the blood alcohol concentration because of the assumption that an end-exhaled breath sample accurately reflects the alveolar (or deep-lung) air which is in equilibrium with the blood.

Many studies have been performed to quantify the relationship between breath alcohol concentration (BrAC) and blood alcohol concentration (BAC) with the goal of defining a precise relationship between the two for accurate non-invasive determination of BAC.

The medical definition for human being is 1g of alcohol in 1 litre of blood corresponds to 1g of alcohol in 2100 litres of exhaled air.

Medical Definition for Human Being:

BAC	Blood Alcohol Content
1 g/l Blood	⇒ 0.476 mg/l air
1g/2100 l Air	

Table 1: BAC vs. BrAC for Human Being

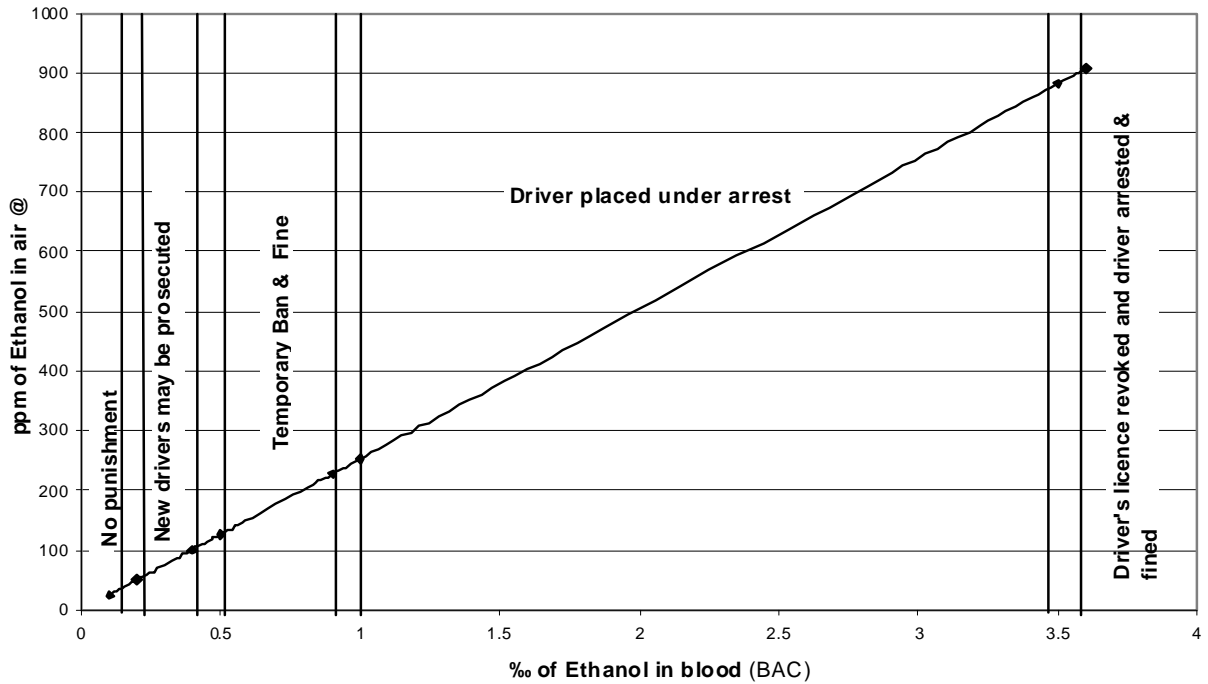

Figure 2: Example of Regulations on Drink Driving

Calculation of the Corresponding Amount of Alcohol in ppm in Air:

Perfect Gas Law: $pV = nRT$ with $n = m/M$

	Normal	Value	Unit
Pressure	$p_0=1.013 \text{ bar}$	101300	N/m^2
Temperature	$T=35^\circ\text{C}$	308	Kelvin
Molar Mass	$\text{C}_2\text{H}_5\text{OH}$	46.07	g/mole
Perfect Gas Constant	R	8.31	$\text{J}/(\text{mole}\cdot\text{K})$
Molar volume @ 35°C	$V_m = (n \cdot R \cdot T) / p = (1 \cdot 8.31 \cdot 308) / 101300$ $V_m = 25.27 \text{ l/mole}$		
Density	$= M/V_m = 46.07 / 25.27 = 1.82 \text{ g/l}$		

mg/l air	ppm
1.82	1000
0.91	500
0.18	100
0.09	50

BAC [%]	[‰] of Ethanol in blood	[ppm] of Ethanol in air
0.01	0.1	26
0.05	0.5	131
0.08	0.8	209
0.2	2	522
0.3	3	783

Table 2: BrAC Calculation for ppm in air

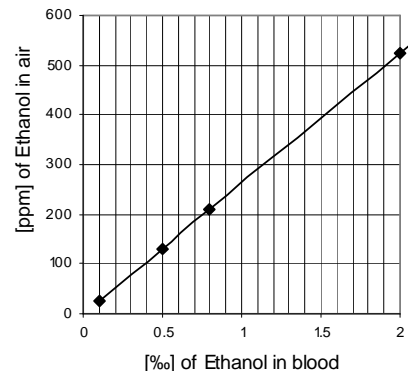

Figure 3 : BAC Vs. BrAC

CALIBRATION

CALIBRATION POINT

As shown by the sensitivity curve, the response to alcohol is not linear. For example at low concentrations (<100 ppm) the sensitivity (expressed as the change in resistance per ppm of ethanol) is higher than at higher concentrations (this is a saturation effect). For this reason it is recommended to use several calibration points for multi-class output. Unless linearisation is used the accuracy of the sensor will decrease at concentrations away from the calibration point.

Class	BAC [‰]	BrAC [ppm]
1	< 0.1	< 26
2	0.2 - 0.4	52 - 104
3	0.5 - 0.8	130 - 208
4	> 1	> 261

Table 3: Example of BAC classes

CALIBRATION SET-UP

Ethanol/air mixtures can be generated by blowing air through an Ethanol/water mixture kept at 37 °C. A suitable bubbler (e.g. glass frit or sinters) should be used to provide optimum mixing of the air and liquid.

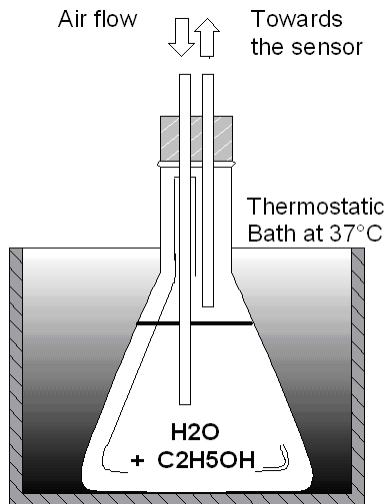

Figure 4 : Calibration Set-up

The resultant air will contain humidity and evaporated alcohol. The ethanol in air concentration follows the Dubowski's formula.

Dubowski's Formula

$$C_{air} = 0.04145 \times 10E-3 C_{water} \times \text{EXP}(0.06583 \times T)$$

where T is the temperature in °C

$$T = 35 \text{ °C}$$

$$k = 0.04145 \times \text{EXP}(0.06583 \times T)$$

$$C_{water} \text{ [g/l]} = C_{water} \text{ [ml/l]} \times \rho_{Ethanol}$$

$$\rho_{Ethanol} = 790 \text{ kg/m}^3$$

$$C_{air} \text{ (g/l)} = k \times 10E-3 C_{water} \text{ (g/l)}$$

$$(1.82 \text{ mg/l} = 1000 \text{ ppm})$$

C _{water} [g/l]	C _{water} [ml/l]	C _{air} [mg/l]	C _{air} [ppm]
0.00	0	0.00	0
0.11	0.145	0.05	26
0.23	0.295	0.10	53
0.47	0.595	0.20	107
0.58	0.74	0.24	133
0.92	1.16	0.38	209
1.15	1.45	0.48	261

Table 4: Water and Air concentration

The volume of pure ethanol is injected in water C_{water} [ml/l] and resulting C_{air} [ppm] is generated and injected to the sensor for calibration.

Water and ethanol mixtures are not stable with time and fresh mixtures should be manufactured when required.

Calibration should be performed in the same conditions as in the application, i.e. the calibration gas should be at 35 °C and 95% RH when reaching the sensor. Temperature, air flow-rate and length of the tubing may need to be adapted to achieve these conditions.

FACTORY CALIBRATION PROCEDURE

The following procedure is used to calibrate the sensor:

1. Set the sensor power to 76 mW.
2. Wait for at least 5 seconds to allow the sensor to reach a stable reading R_{ambient}. As shown in figure 5, there should be <10% R_s variation in the last second.
3. Expose the sensor to simulated ethanol-free breath (35 °C and 95% RH).
4. Allow at least 3 seconds for the sensor reading to stabilise (R_{S_{BrAC}}). There should be <10% R_s variation in the last second.
5. Record the sensor output, this is the zero or reference point.
6. Stop the flow of simulated breath.
7. Repeat steps 2 to 6 with single or multiple simulated breath exposure(s) with ethanol at the target concentrations.

The calibration procedure is performed at ambient conditions 21 °C and 30 to 50% RH.

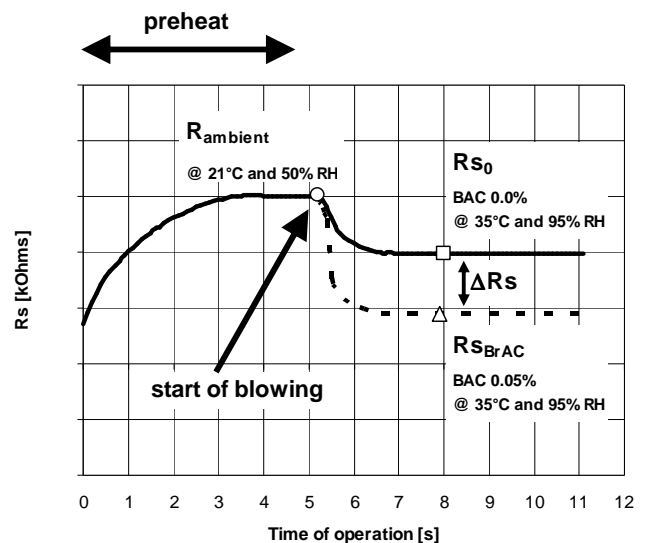

Figure 5: Sensor Output with Breath Exposure

It is advised to repeat the procedure to check the sensor response (occasionally a sensor can show a lower response when initially tested). It is recommended that in the case of significant levels of alcohol being detected, that the test should be repeated to optimise the accuracy.

Accuracy Optimisation and Autozeroing

Semiconductor gas sensors show intrinsic drift of the baseline resistance, R_{S_0} , with time. This change means that it is not possible to use the initial factory resistances in air and in ethanol to calculate the concentration of ethanol at any subsequent test. The difference between the two readings will also change. However, the ratio of the two resistances is a constant. Therefore by regularly measuring the resistance in air containing 0 ppm Ethanol, the concentration of any sample can be calculated by measuring the ratio of the resistances. For example, the initial measured values for $R_{S_0} = 87 \text{ k}\Omega$ and $R_{S_{BrAC}} @ \text{BAC } 0.05\% = 30 \text{ k}\Omega$. The ratio is $= 30/87$.

To perform this calibration proceed as described for Factory Calibration Procedure (points 1 to 7).

USE OF CALIBRATION POINT(S)

Single point calibration needs at least two data points:

- $R_{S_0} @ \text{BAC} = 0.0\% @ 35 \text{ }^\circ\text{C}$ and 95% RH
- $R_{S_{BrAC}} @ \text{BAC} = 0.05\%$ or 130 ppm in BrAC (for example) @ 35 °C and 95% RH

With a simulated breath exhaled at BrAC = 0.0 mg/l, the sensor resistance, R_s , will decrease, i.e. changing from R_{ambient} to R_{S_0} (see Figure 5). This is a result of the sensitivity of the sensor to the exhaled air which is at 35 °C and 95%RH.

Note that the resistances in ethanol-containing breath will always be lower than those in ethanol free breath. If the sensor resistances increase then the measurement is not valid.

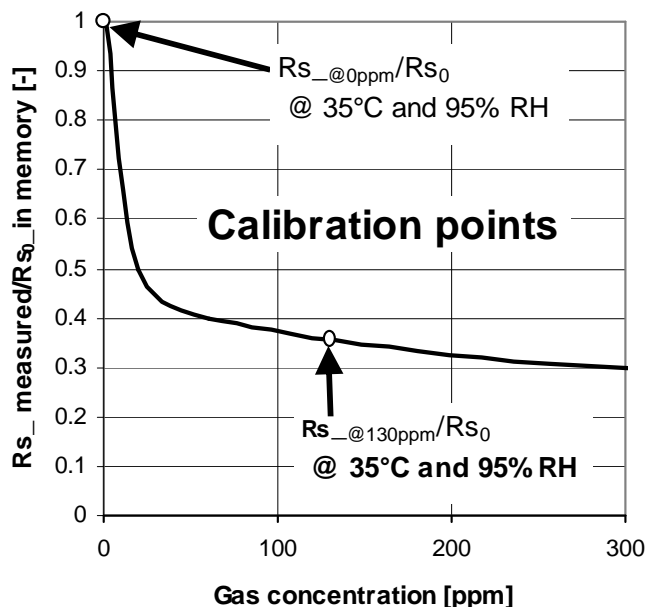

Figure 6: Calibration points for relative sensitivity

With multiple point calibration, the principle is the same but with more exposures at more ethanol concentrations.

For example multi-point calibration of the unit will require the following data:

1. R_{S_0} (base for all ratios calculation and stored again during user autocalibration)
2. Ratio class #1 ($R_{S@26\text{ppm}}/R_{S_0}$) (factory cal.)
3. Ratio class #2 ($R_{S@52\text{ppm}}/R_{S_0}$) (factory cal.)
4. Ratio class #3 ($R_{S@130\text{ppm}}/R_{S_0}$) (factory cal.)
5. Ratio class #4 ($R_{S@261\text{ppm}}/R_{S_0}$) (factory cal.)

To perform accurate measurements around the most critical calibration point (0.05% or 130 ppm for example), the load resistance should be chosen equal to $R_{S_{BAC}}$ measured at this calibration point.

Based on these measurements regression techniques can be used to define the limits of the various BAC classes.

Values used in this example are indicative only and effective measurements need to be done with the actual sensor because of variability within the manufacturing process.

PERFORMANCE

TEMPERATURE AND HUMIDITY DEPENDENCIES

Temperature and humidity changes affect the resistance value of the sensor. Humidity (water in gas phase) reacts with the sensing layer as a reducing gas. Increasing humidity therefore causes a decrease of the sensing resistance. With temperature, the effect is the same as for the humidity, i.e. decreasing resistance with increasing temperature. This negative temperature coefficient is due to the semiconductor properties of the sensing layer material.

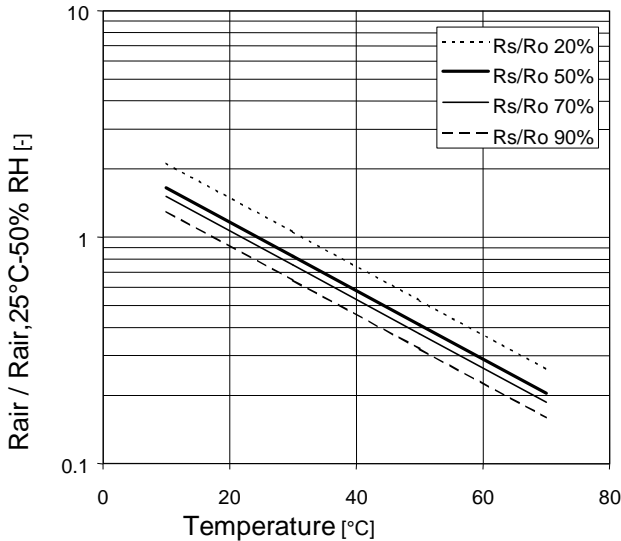

Figure 7: Temperature Dependence of Baseline Resistance Rair for 20%, 50%, 70% and 90% RH.

In the breathalyser application, compensation for temperature and humidity dependencies is not required because the sample gas is human breath, which is consistent in terms of humidity and temperature.

The temperature and humidity of breath is 35 °C and 95% RH. The breath is not 100% saturated because the saturated vapour pressure generated is not above water but above an essentially saline solution (the body). Water molecules are bonded to this saline solution, thus limiting the vapour pressure to 95%. The actual temperature of the breath has been measured and is only 35 °C.

RESPONSE TIME

Using a test gas of 60 ppm of ethanol (0.023% BAC), the sensing resistance reaches 90% of its final change in about one second. The response time is not significantly affected by temperature in the application. This behavior is well adapted to the detection of the alveolar plateau with a response time lower than the time needed for a reliable measurement (see duration of blowing in the Application Design Tips section).

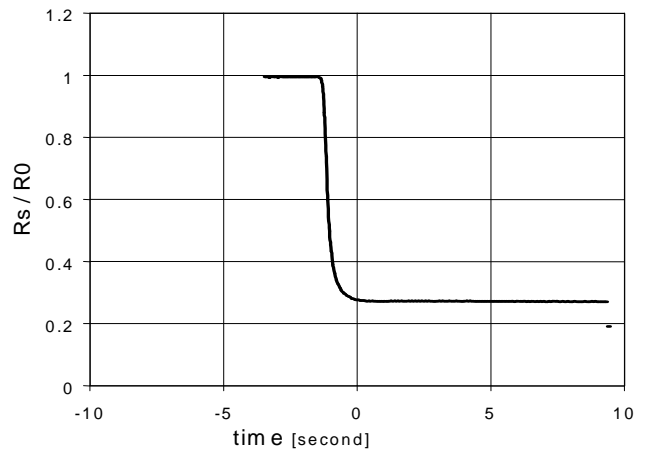

Figure 8: Response Time to 60 ppm C₂H₅OH

INTERFERING GAS FOR THE APPLICATION

Some specific gases can affect the readings, for example:

- **ketones** which can be present in the breath of diabetics or patients whose diets contain a high fat level.
- Gases present in cigarette smoke, e.g. **carbon monoxide** and **acetaldehyde**.
- Compounds such as **acetone**, **isopropyl alcohol** and **methanol**, which can be generated after consumption of fruit juices.

Characterisation of these responses to these compounds at known concentrations needs to be carried out to determine the level of cross-sensitivity. For example, some breathalyser regulations state that atmospheres containing 0.05 mg/l of carbon monoxide should not produce a reading of more than 0.02 mg/l ethanol. This means that in presence of 45 ppm CO the sensor response should be equal or less than at 10 ppm ethanol.

This is the case as shown below:

CO [ppm]	Equivalent C ₂ H ₅ OH Gas concentration [ppm]
0	0
10	1
50	6
100	18
500	274

Table 5: Ethanol equivalence of CO interference with MiCS-5524 sensor

These tests need to be done in order to test the compliance of the breathalyser to the specific regulation.

ELECTRONIC DESIGN

The recommended mode of operation is constant power.

Detection of ethanol is achieved by measuring the sensing resistance of the sensor. The resistance decreases in the presence of ethanol.

Details of the correct connection pins are shown on the relevant datasheet.

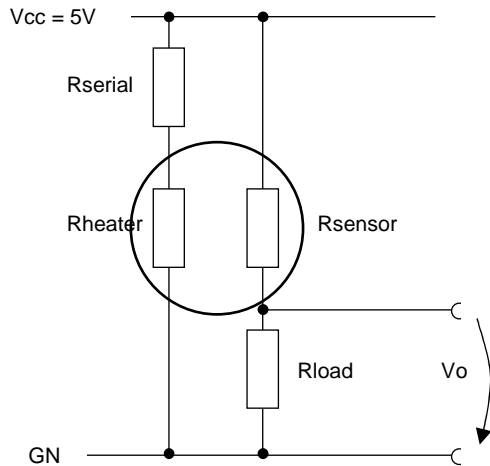

Figure 8: Operating Conditions

SENSOR HEATER

The temperature of the sensing layer is dependent on the heating power and on the ambient temperature. To obtain good sensitivity to the target gas, the sensing layer temperature should stay within a temperature range of 350 °C to 550 °C. Below 350 °C, the sensitivity decreases significantly and the sensor response becomes slower. Above 550 °C, the sensitivity also decreases and the sensor structure can deteriorate due to overheating. Figure 9 shows the relationship between the applied heating power P_h and the resulting temperature increase ΔT with respect to the ambient temperature.

Recommended operating temperature is 350 °C, i.e. 76 mW.

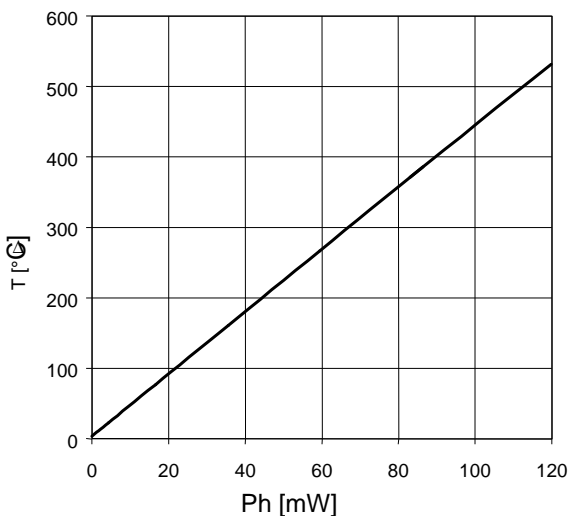

Figure 9: Heating Temperature v. Heating Power

As shown in Figure 10, one external load resistor can be used to power the heater with a single 5 V power supply.

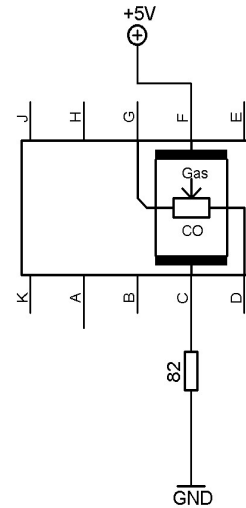

Figure 10: MiCS-5524 with Recommended Supply Circuit (top view)

R is 82 Ω . This resistor is necessary to obtain the right temperature on the heater while using a single 5 V power supply. The resulting voltage is typically $V_H = 2.4$ V.

MEASUREMENT CIRCUIT EXAMPLE

As shown below, the sensor resistance is determined using a load resistor.

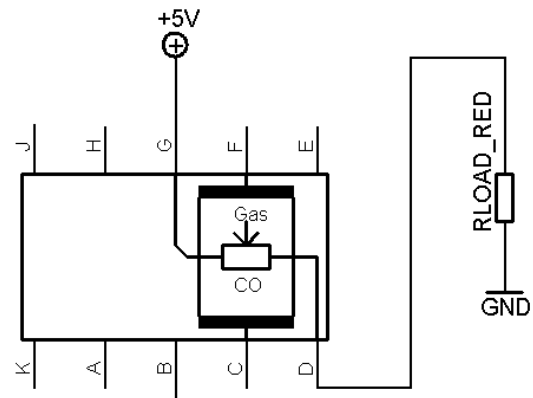

Figure 11: MiCS-5524 with Measurement Circuit (top view)

The voltage measured on the load resistor is directly linked to the resistance of the sensor. RLOAD must be greater than 820 Ω in order not to damage the sensitive layer.

The recommended load resistance is 100 k Ω (see use of calibration points on page 4 for more details).

The resistance R_s can be read with an A/D converter. To adapt the scale to the resistance range, the microcontroller can switch two or three resistors in series. The number of resistors to be switched varies with the precision of the ADC.

The frequency of acquisition should be greater than 4 Hz in order to detect the start of the air entering in the sensor chamber and the detection of the alveolar plateau (stabilised reading) used to determine the BrAC according to calibration.

APPLICATION DESIGN TIPS

PREHEATING

It is recommended to power on the sensor several seconds (up to 30 s) to stabilise the signal before taking the measurement. The preheating time is needed to produce a consistent response irrespective of the ambient conditions and the time since the previous test.

It is useful to indicate that a stable value has been reached (using visual or an audible signal), after which the user then blows, after taking a deep breath, for at least 4 to 5 seconds (see duration of blowing).

MOUTHPIECE

To obtain reliable and repeatable sensor readings requires blowing on the sensor in a defined and reproducible way. The best results are obtained using a mouthpiece. The airflow is thus concentrated and the sample of air reaching the sensor well defined. The mouthpiece can consist of a disposable plastic part inserted in the plastic housing of the breathalyser.

QUALITY OF READINGS

The quality of the reading depends of several conditions: air flow, duration of blowing, time since the last operation, environmental conditions (e.g. temperature and high humidity) and the presence of interfering compounds e.g. cigarette smoke.

Low Temperature – High Humidity

If the temperature is low enough or the humidity high enough, condensation (i.e. "fog") can be observed forming in your exhaled breath.

With exhaled air at 35 °C and 95% RH, condensed water can appear e.g. when the outside air is below 12 °C and 50% RH. In these conditions, water drops will interfere in the readings. **To avoid accumulation of water drops in the sensor area, it is recommended to have the air sample passing through a sensor chamber.**

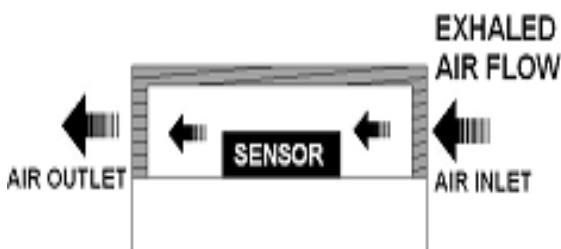

Figure 12: Description of Airflow

The sensor should be perpendicular to the air flow to avoid direct projection on the sensor (saliva, dust, etc).



Figure 13: Example of Plastic Housing for Airflow Conditioning

Duration of Blowing

It is known that the initial air exhaled from the lungs contains air from the airways and has little "alveolar air". Further exhalation results in exhalation of air from the alveoli which contains gas in equilibrium with pulmonary capillary blood.

The first part of the exhaled air comes from the airways and is called the anatomic dead space (phase 1) and the later part of the exhaled air (phase 2 with higher gas concentration) comes from the alveolar regions.

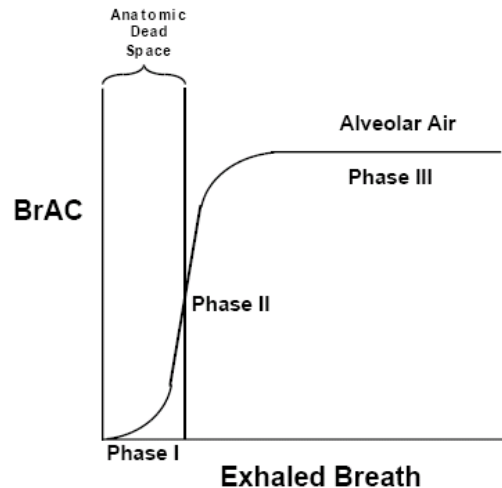

Figure 14: Exhaled Breath Phases

This later part of the exhaled gas profile is known as the alveolar plateau (phase 3). With a presumed flat exhaled alcohol profile, the end-exhaled alcohol concentration is independent of exhaled volume after exhalation beyond the anatomic dead space volume.

Phase 1 lasts a couple of seconds. The alveolar plateau is normally reached after 4 to 5 seconds.

As stated earlier, even with a BrAC of 0 mg/l, the sensor output will vary with the detection of air at 35 °C and 95%RH. If the variation of sensor output is too low between $R_{ambient}$ and R_{S0} (based on the calibration) then the reading is not valid and breathalyser should indicate this with a visual display or an audio signal.

ACCURACY

As with most equipment, it is important for the user to check the device is functioning correctly. Periodic cleaning (no solvents, use only water on a paper tissue) will reduce the risk of dirt and moisture causing malfunction, however the accuracy will need to be checked at regular intervals.

Faults in the user's technique are the most common reason for poor quality readings.

The main errors include:

- Inadequate inhalation before starting to exhale.
- Insufficient sealing around the mouthpiece.
- Slow commencement of exhalation.
- Breathing out stopped before complete expiration.
- Not providing the sample in one blow, e.g. coughing, talking or puffing from the cheeks into the mouthpiece.
- Leakage through the nose during the procedure.

If any of these faults occur the results given will be incorrect and the user will have to restart the process.

It is recommended to the user to check at least two times that the breathalyzer shows consistent readings.

IMPORTANT PRECAUTIONS

Read the following instructions carefully before using the sensor to avoid erroneous readings and to prevent the device from permanent damage.

- The sensor must be reflow soldered in a neutral atmosphere, without soldering flux vapours.
- The sensor must not be exposed to high concentrations of organic solvents, ammonia, silicone vapour or cigarette-smoke in order to avoid poisoning the sensitive layer.
- Heater voltages above the specified maximum rating will destroy the sensor due to overheating.
- This sensor is to be placed in a filtered package (metal mesh) that protects it against water and dust projections.
- SGX Sensortech strongly recommends using ESD protection equipment to handle the sensor.
- For any additional questions, contact e2v.

PROTOCOL FOR EVALUATION OF BREATHALYSER DESIGN

The best way to evaluate the performances of the design is to test the system in real conditions.

To perform this evaluation a sample of persons of both gender and various weight has to be used.

According to the profile of the person under test (weight, gender), the quantity of alcohol ingested and the time elapsed, an estimation of the BAC can be calculated by using the Widmark formula.

BAC is depending of pure alcohol quantity ingested, weight of the person and the gender. Gender is used with distribution coefficient r (0.7 for men, 0.6 for women).

Widmark Formula:

$$\text{BAC (g/l)} = \frac{\text{Pure alcohol (in g)}}{\text{Weight (in kg)} \times r}$$

To calculate real BAC, the following need to be considered:

- Natural elimination (average of 0.15 g/l/h when eating and of 0.10 g/l/h before a meal).
- Digesting helps alcohol elimination.

This BAC is then compared with the sensor response when applying the procedure below:

- 1) Wait 20 minutes after last drink (blowing too soon after last drink gives an inaccurate reading).
- 2) Press start button (activation by the user).
- 3) Wait for device ready indication (preheating time).
- 4) Take a deep breath.
- 5) Blow in the mouthpiece for 4 to 5 seconds.
- 6) Level indication or bad measurement indication (insufficient airflow, too short duration of airflow, etc.)

The test subject should not smoke a cigarette before the test.

To avoid any alcohol residue in the mouth the subject should rinse his/her mouth with water before blowing.

This kind of evaluation allows to estimate the accuracy, repeatability and reliability of the design.

SGX Sensortech semiconductor gas sensors are well suited for leak detection and applications requiring limited accuracy. Their use for absolute gas concentration detection is more complicated because they typically require temperature compensation, calibration, and sometimes as well, humidity compensation. Their base resistance in clean air and their sensitivity can vary overtime depending on the environment they are in. This effect must be taken into account for any application development. (1104 1.0)